



# FLAME EFFECT CERAMIC HEATER INSTRUCTION MANUAL

DHCER20FE



Please read the instructions carefully before use.  
Keep manual for future reference.

This product is only suitable for well insulated spaces or occasional use.

# CONTENTS

Safety Warning and Notices	2
Product Features	4
Components Description	4
Product Operation Introduction	6
Maintenance and Cleaning	8
Technical Parameters	9
Warranty	9

## SAFETY WARNING AND NOTICES

Please pay close attention to the warnings and instructions in this manual for correct operation and to avoid any danger caused by incorrect use.

1. This appliance can only be used by children 8 years and above and people with reduced physical, sensory or mental capabilities or lack of experience and knowledge if they have been given supervision or instruction concerning the use of the appliance in a safe way and understand the hazards involved. Children should not play with the appliance.
2. CAUTION — Some parts of this product can become very hot and cause burns. Particular attention has to be given where children and vulnerable people are present.
3. If the supply cord is damaged, it must be replaced by the manufacturer, its service agent or similarly qualified persons in order to avoid any hazards.
4. WARNING: In order to avoid overheating, do not cover the heater.
5. The heater must not be placed immediately below a socket outlet.
6. Do not use this heater in the immediate surroundings of a bath, shower or a swimming pool.
7. The fan heater can only be used under supervision.
8. The air inlet/outlet area must never be covered. Keep a distance of at least 1m in front and 50cm behind the fan.
9. If there is any indication of a malfunction, contact service center repairs. Do not attempt to disassemble the product or replace faulty parts with unauthorized components because it will damage the unit.

10. Do not disassemble or make changes to the product unless you are authorized by the dealer or producer.
11. Do not touch the plug with wet hands, it may lead to electric shock.
12. Do not put foreign objects into the air inlet or outlet.
13. Do not use pesticide or other flammable sprays around the product.
14. Make sure the fan doesn't blow heated air directly at small children for long periods of time.
15. Do not pull out the power plug by pulling the power cord, it may cause damage to the power cord and cause an electric shock.
16. Make sure the power cord is undamaged, and the plug is correctly plugged into the wall socket.
17. If there is an abnormal smell or noise when the product is in use, turn off the product and pull out the power cord immediately.
18. Do not operate the appliance with a damaged power cord or plug. Send the heater to a suitably qualified or appointed service agent for inspection and repair.
19. Make sure not to fold the power cord or place heavy objects on the power cord, it may lead to electric shock.
20. If the heater will not be used for a long period of time, disconnect the plug.
21. Use a power outlet that meets the inspection requirements where the carrying capacity of the socket is no less than 10A/230V.
22. Ensure the power supply voltage is consistent with the specified voltage in the machine (220-240VAC).
23. Do not use the device directly below a power outlet.
24. When using the heater, keep combustible materials or explosive objectives, away from the heater.
25. In order to avoid overheating, do not cover the heater.
26. Never place any objects inside the device.

## PRODUCT FEATURES

1. PTC ceramic heating element, changes the power automatically according to the variation in the ambient temperature.
2. Optional high or low power.
3. Set timer has a range between 1-24 hours.
4. Temperature setting of 15°C to 35°C.
5. Uses a DC fan, which increases efficiency and has low operational noise.
6. Tip-over safety protection, double over-heating protection (Thermistor, temperature fuse) for safer use.
7. Convenient operation with an infrared remote control function.
8. Oscillating, swing function.
9. LED display will automatically dim after 1 minute during operation, to save energy and power.
10. Optional Flame effect.

## COMPONENTS DESCRIPTION

### PRODUCT STRUCTURE

1. Front cover
2. Wind outlet
3. Flame effect display window
4. Swing holder
5. Base
6. Power cord
7. Control panel
8. Power switch
9. Remote control

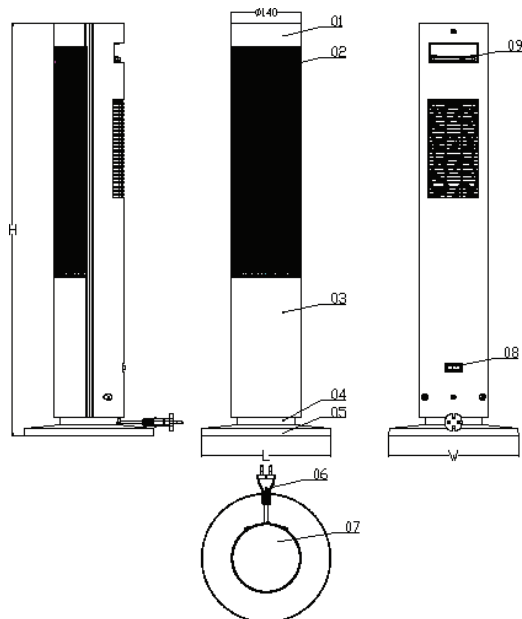

## CONTROL PANEL

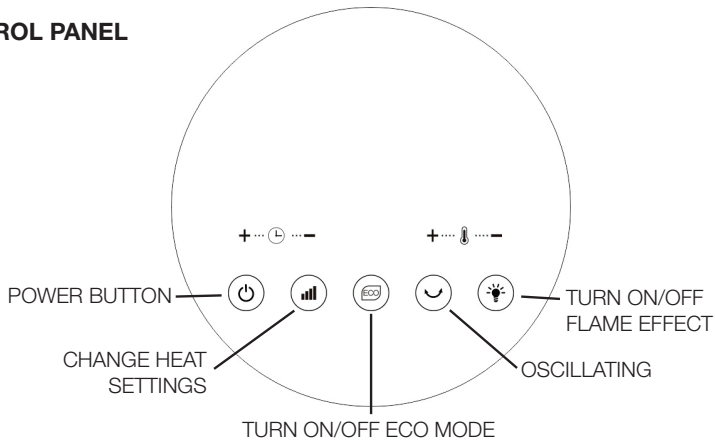

## DISPLAY PANEL

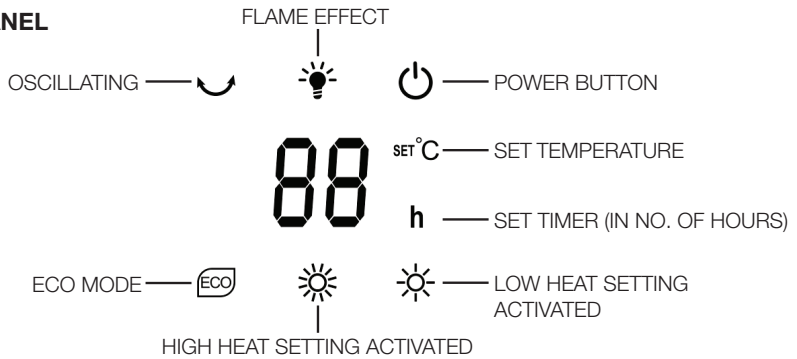

## REMOTE CONTROL OPERATION PANEL

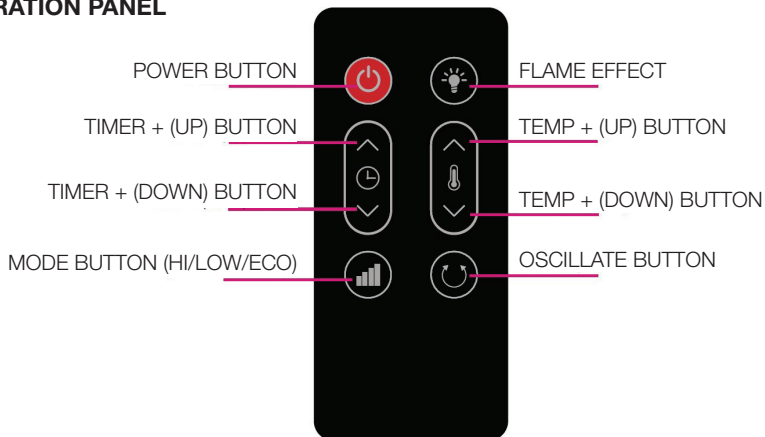

# PRODUCT OPERATION INTRODUCTION

## INSTALLATION METHOD

1. Take the device out of the bubble wrap, including the following three parts; heater, base and remote control.
2. Put the heater on a flat surface upside-down (with the base facing up). Connect the base with the heater.
3. Turn the unit right way up.
4. Press Power button which is in the back of the device, to turn on.



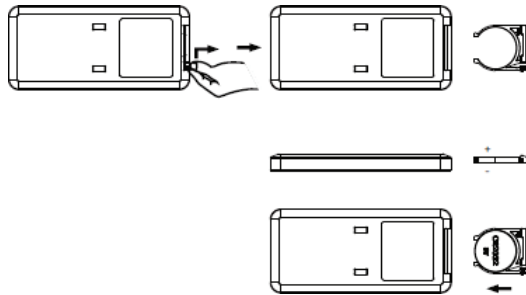

## REMOTE CONTROL OPERATION PANEL



















1. Pull out the battery cover on the back of the remote control.
2. Pay attention to the battery polarity, and insert the battery (CR2032) into the tray of the panel.
3. Push the battery cover back into the remote control.



## THE FUNCTION OF BUTTONS

The fan will operate whenever the heater is heating. If the heater stops working, then the fan will stop working after 10s.

1. After connecting to the power supply and switching on the power, you will hear a beeping sound, the heater then enters Standby Mode. The power indicator  lights up.
2. Under standby mode,  key to turn on/off the heater. When turning off the heater, the display panel and fan will then countdown (from 10 to 0 second) before switching off.
3. The default setting after being switched on is:
  - a) Heater: low power,  lights up.
  - b) Oscillation: off,  lights off.
  - c) Timer: 0 hrs, **h** lights off.

- d) Fan: turned on.
  - e) Temperature setting: the default temperature setting is 25°C.
  - f) Fireplace display: turned on, ☀ lights up.
  - g) ECO: turned off,  lights off.
4. In heating mode, press  to shift the power between low and high power level.
    - a) Low power: ☀ lights up.
    - b) High power: ☀ lights up.
  5. In heating mode, press  to enter ECO mode,  lights up, press it again to quit this mode.
    - a) ECO mode: the default temperature setting is 22°C. When the room temperature is lower than 18°C, the machine works in high power: when the room temperature is between 18°C and 22°C the machine works in low power. When the room temperature is above 22°C the heating element will turn off.
    - b) When the ECO function is operating, the  button is not active.
    - c) When the room temperature is above 22°C the heater and oscillation function will also be turned off.
  6. In heating mode, press  to turn on/off the oscillation function,  will light up/off accordingly.
  7. In heating mode, press  or  button to set the timer.
    - a) Timer: press  or  key, **88** and **h** will display, press +/- key to set the timer (within a range of 0-24 hours), the timer will increase or decrease by 1hr increments.
    - b) Entering the timer mode by pressing  or  does not change the timer settings. But you can set the timer by pressing the +/- key. After no operation for 5 seconds, the time that you have set will be saved.
    - c) When the timer turns to the value "0", the device will then turn off and enter into standby mode.
    - d) If the timer is set as "0", it means that no timer is set.
  8. In heating mode, press  or  button to set the temperature.
    - a) Temperature setting function: press  or  key, **88** and SET°C will display, press +/- key to set the temperature. The range of the temperature is from 15°C to 35°C, and can increase or decrease by 1°C increments.
    - b) Entering into the temperature settings by pressing  or  keys does not change the temperature settings. You can set the temperature by pressing +/- key. After no operation for 5 seconds, the temperature that you have set will be saved.

9. When both the time and temperature are set, the LED display will switch between showing the set temperature and timer setting every 30 seconds. When a timer is not set, it will only show the set temperature.
10. When the heater is turned on or in standby mode, press  button to turn on/off the flame effect function, the LED will light up/off accordingly.
11. Memory function in standby mode:  
When the heater is turned on (except for the first time), under standby mode, the unit will revert to the last used setting (except for the timer).
12. After working for 1 minute, the brightness of the LED display will reduce to 1/3 of the normal brightness. It will resume to the normal brightness when any operation of the device is activated.
13. If the unit falls over the tip-over switch inside the heater will disconnect the heater automatically.
14. Remarks:
  - a) when the over-heat sensor is activated (temperature is above 60°C), the LED display will display “EE”, and the heater will turn off.
  - b) When the environment temperature is lower than -10°C, the LED will display “LO”
  - c) When the environment temperature is higher than 40°C, the LED will display “HI”

## MAINTENANCE AND CLEANING

1. Before any cleaning or maintenance, make sure the heater is completely turned off, and the power cord is not connected to the wall socket.
2. Use a soft cloth to wipe the dust off the heater's surface; If the surface is very dirty, use a moist soft cloth to wipe it with water less than 50°C mixed with a neutral detergent.
3. Do not use gasoline, thinner or any other chemicals that can damage the surface.
4. Before storing the heater, let it cool down and store it in a dry and ventilated area.
5. Warning: any other servicing should be performed by an authorized service representative.



## TECHNICAL PARAMETERS

<b>Model NO.</b>	DHCER20FE
<b>Voltage</b>	220-240V
<b>Frequency</b>	50 Hz
<b>Power</b>	2000 W
<b>Noise level.</b>	≤50 dB
<b>Dimension</b>	260mm x 260mm x 830mm

## WARRANTY

This device comes with a 2 year warranty from the date of purchase. Keep your receipt as proof of purchase date. This guarantee only applies if the item has been used as intended, and all instructions have been followed accordingly. Please note that this product is for domestic use only and not for commercial use. Improper use of the product will invalidate the guarantee. Returned goods can be accepted if repackaged in the original product box, and presented with the original receipt.

## IMPORTANT



Do not dispose this product as unsorted municipal waste, use separate collection facilities. Contact your local government for information regarding the collection systems available. If electrical appliances are disposed of in landfills or dumps, hazardous substances can leak into the ground water, polluting the food chain and damaging health and well-being.



**Glen Dimplex New Zealand Ltd**

38 Harris Road, East Tamaki  
Auckland, New Zealand  
P.O. Box 58473, Botany  
Manukau 2163, New Zealand

Phone: 09 274 8265

Fax: 09 274 8472

Email: [sales@glendimplex.co.nz](mailto:sales@glendimplex.co.nz)

Web: [www.dimplex.co.nz](http://www.dimplex.co.nz)