

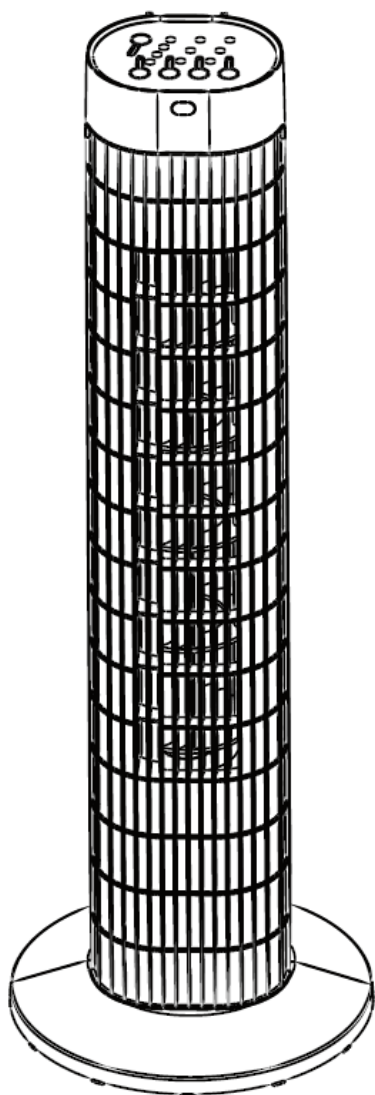

INSTRUCTION MANUAL



Dimplex Tower Fan

Models: DCTFE77

For domestic household use only.



IMPORTANT

THESE INSTRUCTIONS SHOULD BE READ CAREFULLY AND RETAINED FOR FUTURE REFERENCE. **Note also the information presented on the appliance**

CAUTION: FAILURE TO FOLLOW THESE INSTRUCTIONS MAY CAUSE INJURY AND/OR DAMAGE AND MAY INVALIDATE YOUR GUARANTEE

Please read the operating instructions carefully before using your tower fan for the first time and keep them in a safe place.

WARNING

- To prevent against the risk of electric shock never immerse the appliance in water or other liquids.
- Never operate the appliance if a cable or connector has been damaged, after appliance malfunction or if the appliance was dropped or is otherwise damaged.
- If the mains lead is damaged it must only be replaced by the manufacturers service agent or a similarly qualified person in order to avoid a hazard.
- Please ask a professional service agent to repair the product. Improper repair may cause danger to users.
- Disconnect the appliance from mains power whenever it is not in use, before relocating it, and before cleaning.
- Operate the appliance only at the voltage specified on the rating label.
- This appliance can be used by children aged from 8 years and above and persons with reduced physical, sensory or mental capabilities or lack of experience and knowledge if they have been given supervision or instruction concerning use of the appliance in a safe way and understand the hazards involved. Children shall not play with the appliance. Cleaning and user maintenance shall not be made by children without supervision.
- Keep electrical appliances out of reach from children or infirm persons. Do not let them use the appliances without supervision.

RULES FOR SAFE OPERATION

- Never insert fingers, pencils, or any other object through the grille when tower fan is running.
- Disconnect the tower fan when moving from one location to another.
- Be sure the tower fan is on a stable surface when operating to avoid overturning.
- DO NOT use the tower fan in a window, rain may create an electrical hazard.
- Household use only.

Installation Instructions

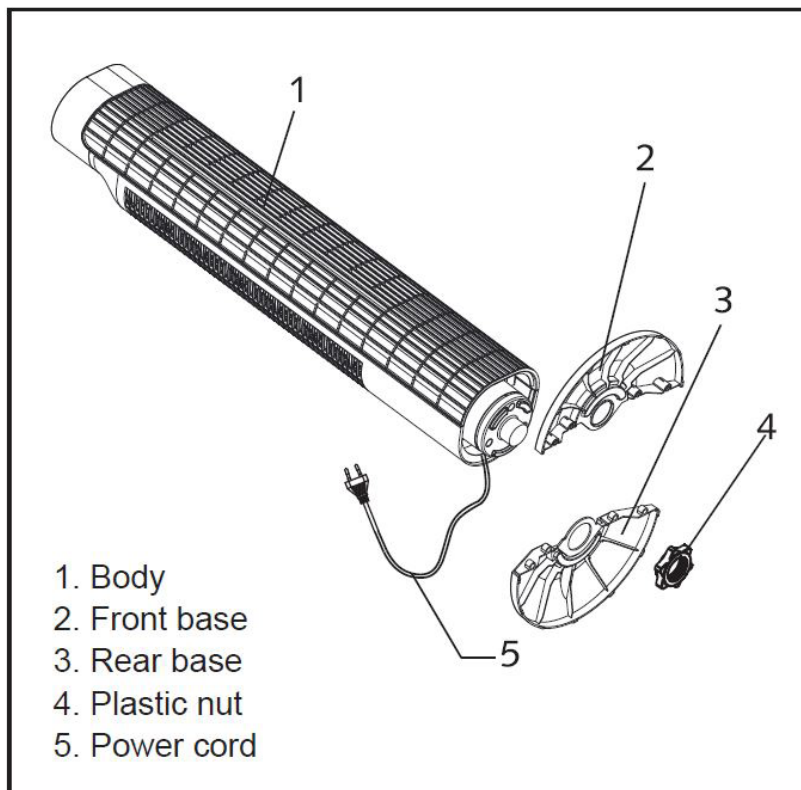

Note: All the pictures in this manual are for explanation purpose only. Any discrepancy between the real object and the illustration in the drawing shall be subject to the real subject.

1. Take out the tower fan body and the spare parts from the box. Put the front base onto the rear base and join them together (see Fig. 1).
2. Unlock the plastic nut from the fan body.
3. Pass the power cord through the flute, then insert the fan body into the base (see Fig. 3).
4. Fix the fan body onto the base with the plastic nut (see Fig. 2).

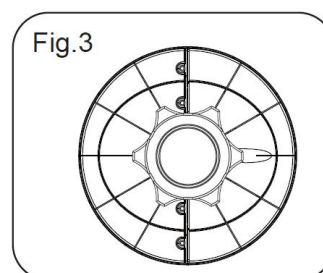
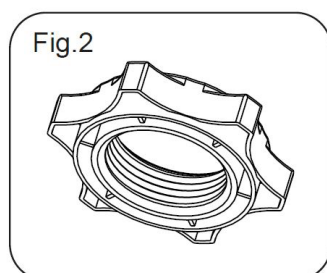
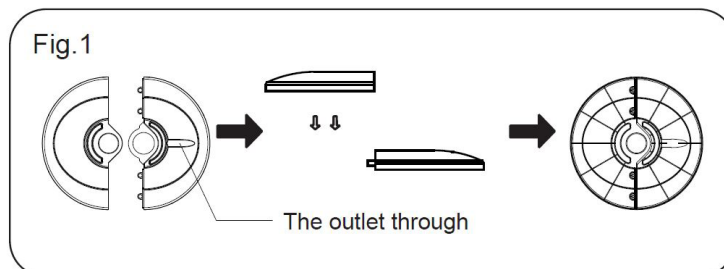

Instructions For Use

Remote control instructions

- Note: effective range of the remote control is within 5m distance and 30 degree range in front of the tower fan.

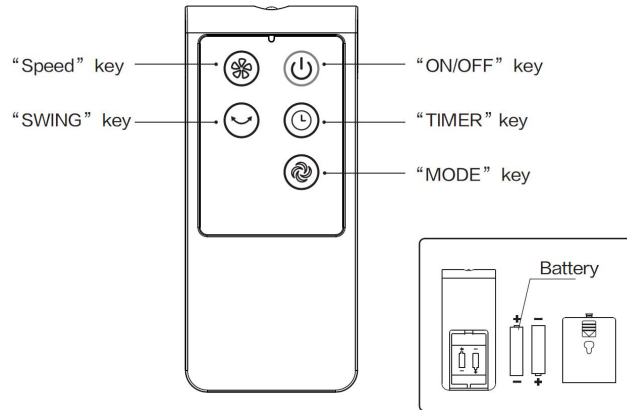

Display panel instructions

Press a key on the unit to activate a corresponding function.

- Press [OSC] key to activate or deactivate swing/oscillation function
- Press [SPEED] key to rotate between 3 different wind speeds
- Press [MODE] key to rotate between the different wind modes

Normal Mode: Operates normally with the selected wind speed

Natural Breeze Mode: The fan speed automatically shifts through different wind speeds to imitate a natural wind speed rhythm.

Sleep Mode: The fan will automatically lower the set wind speed in intervals depending on the speed setting chosen and then run continuously at low speed.

Sleep on High: high speed for half an hour, then medium speed for half an hour, then low speed continuously.

Sleep on Medium: medium speed for an hour, then low speed continuously.

Sleep on low: low speed continuously.

- When the tower fan is on, press the [TIMER] key to set the tower fan to automatically shut down after 0.5 - 7.5hrs. Alternatively in stand-by mode you can pre-set the fan to start in 0.5 - 7.5hrs.

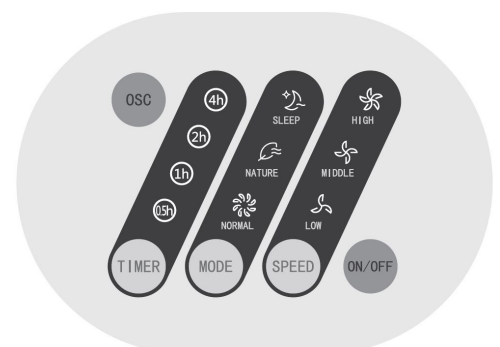

Maintenance Instructions

The tower fan requires little maintenance. Do not try to fix it by yourself. Refer it to a qualified service person if service is needed.

1. Unplug the tower fan before cleaning and assembling
2. To ensure there is adequate air circulation to the motor, keep the rear vents free of dust. **DO NOT** disassemble the fan to remove dust.
3. To clean exterior parts, wipe with a soft cloth soaked in mild detergent
4. **DO NOT** use any abrasive detergents or solvents to avoid scratching the surface
5. **DO NOT** use any of the following as a cleaner: gasoline, thinner, bending.
6. **DO NOT** allow water or any other liquid into the motor housing or interior parts

Disposal

DO NOT dispose of electrical appliances as unsorted municipal waste, use separate collection facilities. Contact your local government for information regarding the collection systems available. If electrical appliances are disposed of in landfills or dumps, hazardous substances can leak into the groundwater and get into the food chain, damaging your health and well-being.

