

# Dimplex

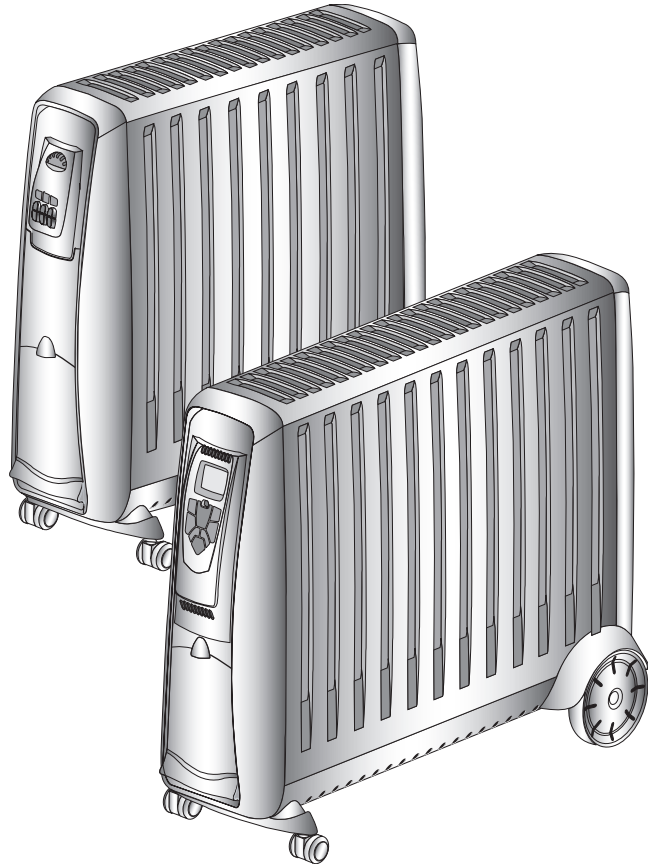

**CDE2TI, CDE2TIB, CDE2ECC, CDE2ECCB,  
CDE24ECC & CDE24ECCB**

**AUS/NZ**



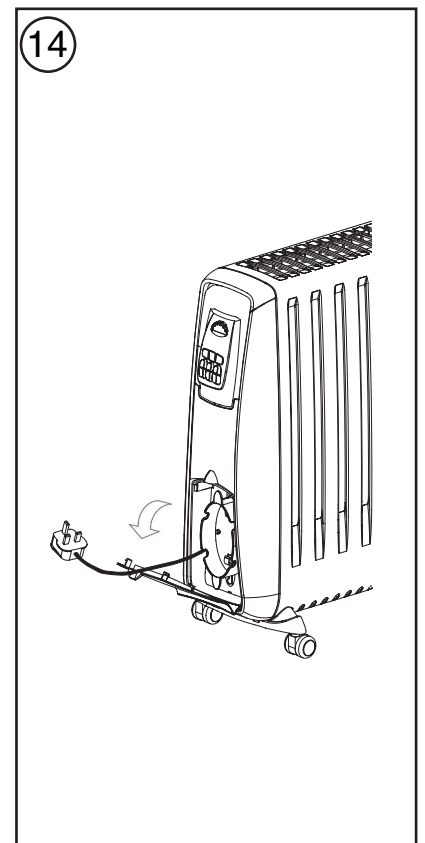
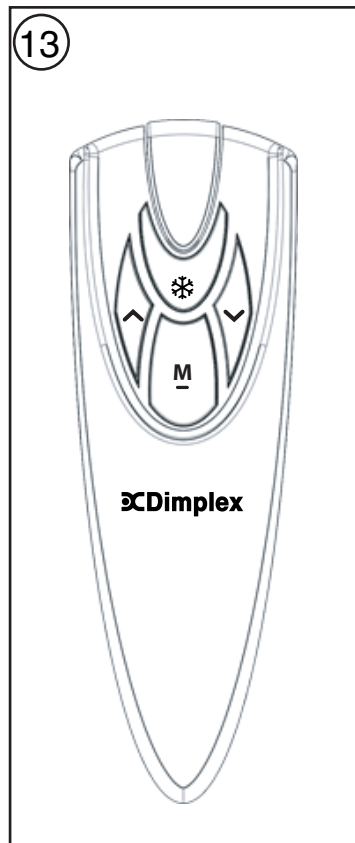
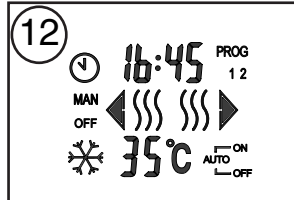
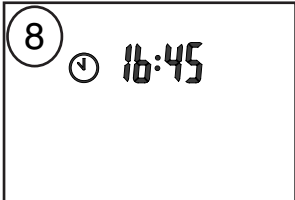
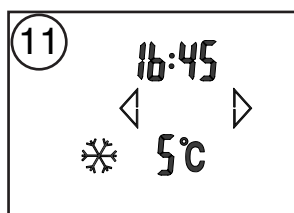
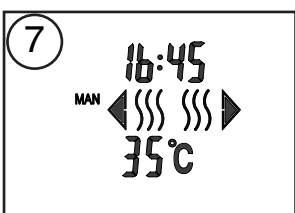
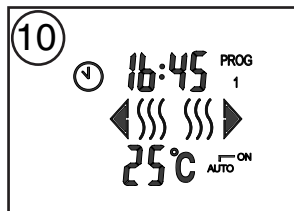
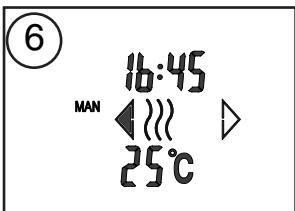
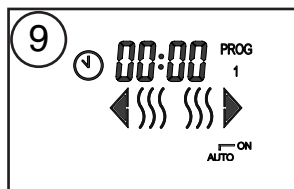
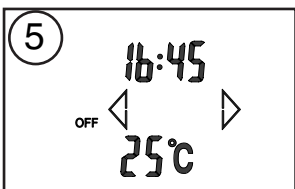
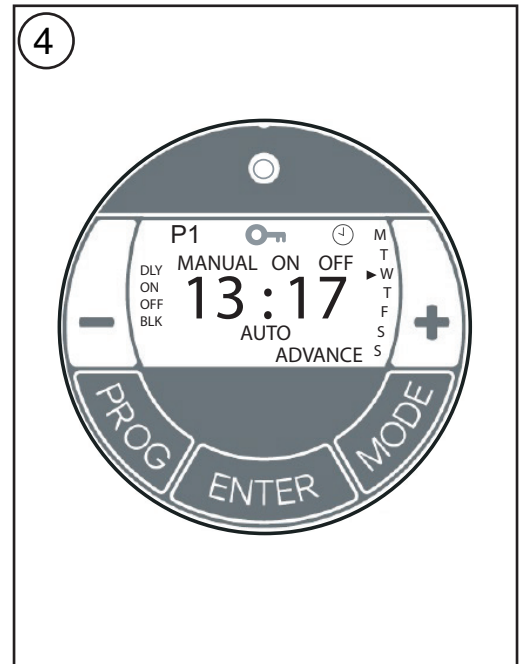
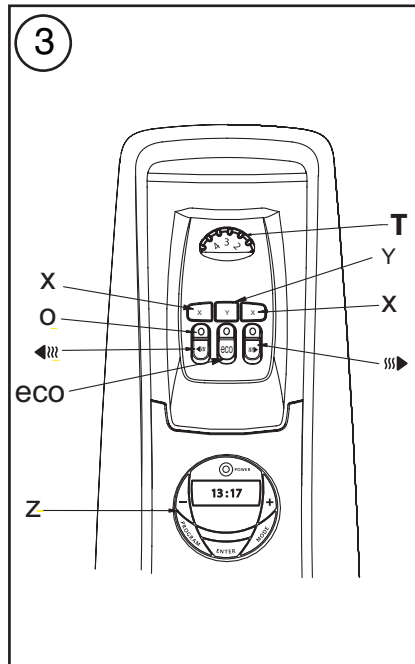
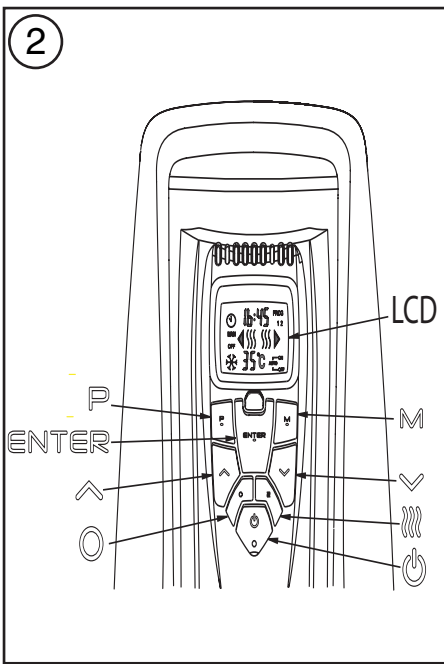
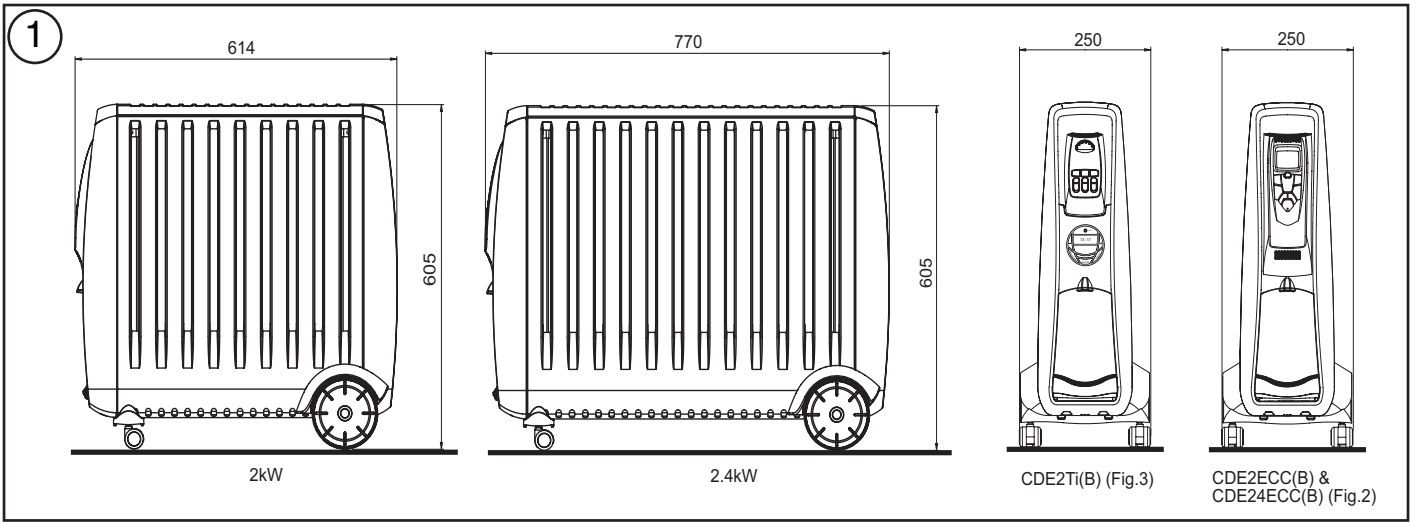

# Dimplex Cadiz Eco

Models : CDE2TI(B), CDE2ECC(B) and CDE24ECC(B)

THESE INSTRUCTIONS SHOULD BE READ CAREFULLY AND RETAINED FOR FUTURE REFERENCE

Model	Description	Watts
CDE2TI(B)	Switch, Thermostat & Digital Timer Control	2000
CDE2ECC(B)	Electronic Climate Control	2000
CDE24ECC(B)	Electronic Climate Control	2400

## Important Safety Advice

If the appliance is damaged, check immediately with the supplier before installation and operation.

This appliance can be used by children aged from 8 years and above and persons with reduced physical, sensory or mental capabilities or lack of experience or knowledge if they have been given supervision or instruction concerning the use of the appliance in a safe way and understand the hazards involved. Children shall not play with the appliance. Cleaning and user maintenance shall not be made by children without supervision.

Children of less than 3 years should be kept away unless continuously supervised. Children aged from 3 years and less than 8 years shall only switch on/off the appliance provided that it has been placed or installed in its intended normal operating position and they have been given supervision or instruction concerning the use of the appliance in a safe way and understand the hazards involved. Children aged from 3 years and less than 8 years shall not plug in, regulate and clean the appliance or perform user maintenance.

**CAUTION:** Some parts of this product can become very hot and cause burns. Particular attention has to be given where children and vulnerable people are present.

**WARNING:** This appliance must not be used in a bathroom.

**WARNING:** Do not use in areas where petrol, paint or flammable liquids are used or stored.

**DO NOT** put objects through the openings of the appliance. This could lead to functional faults, possibly to the ignition of the object.

If the mains lead is damaged, it must be replaced by the manufacturer or its service agent or a similarly qualified person in order to avoid a hazard.

**CAUTION:** Avoid use of an extension cord because the extension cord may overheat and cause risk of fire.



The heater carries a warning symbol to alert the user to the risk of fire that exists if the heater is accidentally covered.

Unplug the heater when not required for long periods.

**WARNING:** Do not use this heater in the immediate surroundings of a bath, a shower

or a swimming pool.

**WARNING:** This heater must not be located immediately below a fixed socket outlet.

**WARNING:** In order to avoid a hazard due to inadvertent resetting of the thermal cut-out, this appliance must not be supplied through an external switching device, such as a timer, or connected to a circuit that is regularly switched on and off by the utility.

Note that due care and consideration must be taken when using this heater in series with a thermal control, a program controller, a timer or any other device that switches on the heat automatically, since a fire risk exists when the heater is accidentally covered or displaced.

## General

The heater is designed for operation on an AC electricity supply, and is suitable for use in domestic dwellings and similar indoor locations.

Always ensure that the appliance is stood on a firm, level base near to, but not directly beneath, a suitable fixed socket outlet.

The heater is fitted with wheels, castors and a handle for ease of movement. Selector switches provide a choice of heat output and an adjustable thermostat enables the room temperature to be controlled accordingly. It is supplied with a cord and plug ready for use.

The supply cord should be uncoiled before use (see 'Storage').

DO NOT pull the heater along by the mains lead.

Important: The heater must only be operated with the wheels and castors fitted and in the upright position as shown in **Fig. 1**.

Warning: The heater complies with stringent safety standards but to ensure efficient operation surfaces of the heater will become hot and contact with these areas should be avoided, particularly between the air outlet slots on the top and sides.

The control panel area is designed to be at a far lower temperature to allow the safe operation of the controls at any time. Momentary contact with any part of the heater should not cause injury. However aged, infirm persons or young children should not be left unsupervised in the vicinity of the heater. Please Note: After switching the heater on for the first time and after an extended period of non-use a smell may be noticed, this is quite normal, the fumes are non-toxic and will quickly disappear. We recommend that you open a window to ventilate the room when using the heater during this time. Used in an environment where background noise is very low, it may be possible to hear a sound which is related to the element. This is normal and should not be a cause for concern.

## Electrical

**WARNING: THIS APPLIANCE MUST BE EARTHED**

**CAUTION:** If you use this heater in conjunction with a thermal control, programme controller, timer or any other device which switches the heater on automatically observe all safety warnings at all times.

## Positioning the Heater

Select the position for the heater ensuring there is clearance from any furniture and fittings of at least 300mm above the heater and 150mm each side. The appliance should only be operated on a flat stable surface.

## Operation

Important – Objects or clothing must not be placed on this heater. Before using the heater ensure that all warnings and instructions have been read carefully.



To bring the heater into use plug it in. Neon indicating lights located at the controls area will glow when the appliance is actually heating.

## Controls



**On/Off button** - This button controls the electricity supply to the elements. When the On/Off button is activated a neon light 'x' illuminates below the control button.

## Thermostat (CDE2TI(B) models only)

The Thermostat (see 'T' in **Fig. 3**) controls the heat output according to the room temperature. This ensures that the heater will not produce heat unnecessarily when the room is warm. To set the temperature you require, turn the thermostat knob clockwise until the required setting is reached. Alternatively to heat a cold room quickly, turn the thermostat knob up fully. When the room has reached the desired temperature, turn the thermostat knob anti-clockwise until the thermostat just clicks off. The heater will now automatically operate at this temperature. The thermostat also has a frost protection setting marked . This setting is useful in areas such as garages, to prevent frost damage. If the thermostat is set to its minimum setting , the heater will cycle on and off to maintain a temperature of approximately 5° to help protect against frost.

**Note:** Should the heater fail to come on when the thermostat is at a low setting, this may be due to the room temperature being higher than the thermostat setting.

## Heat Selector Switches (CDE2TI(B) models only)

### Mono and Dual Panel Heat Settings

Selector switches located on the control panel provide a choice of **Half Heat** or **Full Heat** output to suit varying conditions and for economy of operation.

 **Half Heat Setting - left hand side** - This switch as shown in **Fig. 3** provides half heat output when activated. When it is activated a neon light 'x' illuminates below the control button and the left hand side element turns on.

 **Half Heat Setting - right hand side** - This switch as shown in **Fig. 3** provides a half heat output when activated. When it is activated a neon light 'x' illuminates below the control button and the right hand side element turns on.

 **High Heat Setting** - With both switches activated (see **Fig. 3**) the maximum output of the heater can be achieved. When both switches are activated neon lights 'x' below each control button illuminate.

**Note:** The heater will only operate when the On/Off button is activated.

## Digital Timer Operation (see 'z' in **Fig. 3** & **Fig. 4**)

(CDE2TI(B) models only)

**IMPORTANT:** Remember to observe all safety warnings when operating the heater on auto setting, either attended or unattended.

The timer allows you to select 'AUTO' or 'MAN ON' by pressing the 'MODE' button until the required MODE appears at the bottom of the timer display.

'MAN OFF' MODE heat is permanently off. This is also the default screen.

'MAN ON' MODE allows power to the heater uninterrupted by the program settings.

'AUTO DLY' switches the heater ON and OFF every day according to a set daily program.

'AUTO BLK' switches the heater ON and OFF according to a set of programs for weekdays only or weekends only.

### Key Lock:

If 'ENTER' and 'MODE' are pressed within 1 second, the keys will be locked. The user will know the keys are locked as the lock symbol  will be displayed on the top left hand corner of the screen. To unlock the keypad, press 'ENTER' and then 'MODE' within 1 second.

## Initial Operation

For initial use, plug the heater into a regular household power point and turn the power on. The timer is now ready to be set up for use.

## Setting Current Time

1. Hold the 'PROGRAM' button until the clock symbol  appears on the screen. The user can now set the clock.
2. The hour digit will flash. To adjust the hour use the '-' & '+' buttons. Confirm the hour digit by pressing 'ENTER'.
3. Once 'ENTER' has been pressed the minutes will flash. To adjust the minutes use the '-' & '+' buttons. Confirm the minute digit by pressing 'ENTER'.
4. The timer now returns to the default display.

Once the correct time is set, a total of four ON/OFF time programs can be set for operation.

## Setting Programmes

**OPTION 1;** Daily ('DLY' on display): This is a daily program function, Monday to Sunday with four ON/OFF program options available.

**OPTION 2;** Block ('BLK' on display): This is a block program function, Monday to Friday with four ON/OFF program options or Saturday to Sunday with four ON/OFF program options.

Press the 'PROGRAM' key to set the programs starting with 'Daily ON' P1.

### SETTING P1 ON TIME:

1. To set the hour use the '-' & '+' buttons. Confirm the hour digit by pressing 'ENTER'.
2. To set the minutes use the '-' & '+' buttons. Confirm the minute digit by pressing 'ENTER'.

**Note:** The minutes can only be set in 10 minute blocks in programme 'MODE'.

### SETTING P1 OFF TIME:

3. To set the hour use the '-' & '+' buttons. Confirm the hour digit by pressing 'ENTER'.
4. To set the minutes use the '-' & '+' buttons. Confirm the minute digit by pressing 'ENTER'.

Repeat steps 1 to 4 to programme P2, P3 & P4. After programming P4 'OFF' you automatically exit to the default display.

At any time while programming the timer you can press the 'PROGRAM' button to exit to the default display.

**Note:** If the 'ON' time is the same as the 'OFF' time the appliance will ignore the program.

## The Advance Function

When in 'AUTO' MODE, if the '+' button is pressed for longer than 2 seconds the programme will ADVANCE to the next setting programmed and will only revert back to the program when the subsequent programme time is reached. When the 'ADVANCE' function is running the 'ADVANCE' segment will be displayed on the LCD screen. If the '-' button is pressed when the 'ADVANCE' programme is running the 'ADVANCE' feature will be automatically cancelled and the programme will run as normal.

**Note: Timer Memory Back Up Batteries** - Once the heater has been left plugged in with the socket switched on for at least 72 hours the timer's memory back up batteries will be fully charged.

Once the timer batteries are fully charged, if there is a power cut or if the heater is disconnected from the mains for less than six months, then the timer will continue to keep time & the settings in the memory will remain intact.

If however the timer back up batteries have not been charged fully, or if the heater is deprived of power for longer than six months, then the time and the programme settings are likely to be lost and you may therefore need to reset the time and the programme before using the AUTO MODE again.

## Electronic Climate Control - see **Fig. 2**

(CDE2ECC(B) & CDE24ECC(B) models only)

### Operation



The electronic control allows **MANUAL** and **AUTO** operation.

In **MANUAL ON** mode there are three heat settings:

L/H Side Heat, R/H Side Heat and High Heat



In **AUTO** mode the heater comes on as per the programmed timer settings (see Setting programs). At any point if the heater is active i.e. heat is being produced, the  neon is lit - see **Fig. 2**.

### Initial Operation

When the heater is connected to the mains the  neon will be lit and the display is blank. Press the  button and the display goes to full heat set to 35°C - see **Fig. 7**.

**Note:** All display characters are displayed in **Fig. 12**.

### Standby Mode

With the heater **ON** if the  button is pressed, the heater will go into standby mode, heater switches off, the display goes blank and only the **MAINS ON** neon  remains lit. On pressing the  button again the heater will come on in the mode and with the settings it had prior to going into standby mode.

### Setting Time

1. Press and hold 'P' and the clock symbol  appears on the top left hand side of the screen. The user can now set the time.
2. The hour digit will flash. To adjust the hour use the '↖' & '↘' buttons. Confirm the hour digit by pressing 'ENTER'.
3. The minute digit will flash. To adjust the minute use the '↗' & '↙' buttons. Confirm the hour digit by pressing 'ENTER'. The display will return to the state before entering set time.

**N.B.** If no keys are pressed after 4 minutes the display will revert to the state prior to entering set time.



## Manual Operation

Pressing 'M' from the default **HIGH** screen (Fig. 7) brings the heater into **AUTO** mode - see 'Setting the Timer Programs'. Press again to put the heater into **OFF** mode - see Fig. 5. Press again for left hand side heat (◀|||) appears on LCD display - see Fig. 6). Press again for right hand side heat (|||▶) appears on LCD display). Press again brings the user full circle to **FULL** heat mode (◀|||▶) appears on LCD display).

## Setting the Desired Temperature

The desired temperature can be set using the '▲' or '▼' keys. The temperature can be set from 5°C to 35°C and this will be shown on the display. When the temperature is reached the heater will automatically switch **OFF**. If the ambient temperature drops the heater will come on again automatically. Note the electronic climate control device conserves energy and assists with temperature regulation e.g. if the heater is set to **HIGH** heat and the temperature is set to 28°C, at 27°C the heater will switch to a lower heat setting. Then at 28°C the heater will switch off completely.

## Setting the Timer Programs

Two program settings are possible, **P1** and **P2**. Only high heat is possible for program settings. Press 'P' once to set the programs, starting with **P1 AUTO ON** - See Fig 10.

1. The hour digit will flash. To adjust the hour use the '▲' & '▼' buttons. Confirm the hour digit by pressing 'ENTER'.
2. The minute digit will flash. To adjust the minute use the '▲' & '▼' buttons. Confirm the hour digit by pressing 'ENTER'.
3. Now **P1 AUTO OFF** is displayed, **P1** off time can now be set. Repeat steps 1 & 2 to set **P1** off time.  
At this point either:  
(a) Press 'P' to exit the Program mode and return to **AUTO** mode. The heater is now in **AUTO** mode. The heater will switch **ON** and **OFF** depending on programme **P1** previously entered.  
OR  
(b) Repeat steps 1 - 3 as above to set the programme for **P2**.

At this point press **ENTER** or **PROG** to exit the Programme mode. The heater is now in **AUTO** mode. The heater will switch **ON** and **OFF** depending on programme **P1** & **P2** previously entered. If after programming and returning to the **AUTO** mode display, **P1** or **P2** is active, the display will show **PROG 1 AUTO ON** or **PROG 2 AUTO ON** depending on which is active - see Fig. 10. An **OFF** time cannot be entered which is less than the corresponding **ON** time. When setting the timer programs if no keys are pressed, the display will (after 4 minutes) revert to the previous display i.e. display prior to entering Program mode.

## Run Programs

If **MODE** is pressed until **AUTO** appears on the screen (either **AUTO-ON** or **AUTO-OFF**), the heater will run both **P1** and **P2** program as they are set.

**NOTE: The heater cannot be programmed to run P1 only or P2 only.**  
To cancel **P1**, set **P1 OFF** time to be same as **P1 ON** time. To cancel **P2** set **P2 OFF** time to be same as **P2 ON** time.

## Review Program settings

To review the program settings the heater must be in **AUTO** mode. Press **ENTER** and the times for **PROG 1 ON**, **PROG 1 OFF**, **PROG 2 ON** and **PROG 2 OFF** will be displayed consecutively for 2 seconds. The display will automatically return to the state it was in before **ENTER** was pressed.

## FROST Protection Mode

With the heater in any mode, **OFF**, **MANUAL ON** or **AUTO**, if the displayed set temperature is reduced to 5°C the heater will go into **FROST** Protection mode - see Fig. 11. In this mode only, if the ambient temperature drops below 5°C, will the heater come on. This is to prevent freezing. In **FROST** Protection mode the heater comes on in the high heat mode only. Pressing the 'M' button is the only way to bring the heater out of this special mode.

## Remote Control Operation - see Fig. 13

(CDE2ECC(B) & CDE24ECC(B) models only)

The batteries for the remote control are not installed in the remote but are packed separately in the carton. To install batteries please follow diagrams behind battery cover on the remote control.

The remote allows the set temperature to be adjusted, the mode to be selected or can be used to put the heater in **FROST** Protection mode.

**Full Heat** output can only be achieved when using the remote control i.e. both **Left hand** and **Right hand** panels are on.

Press the 'M' button on the Remote Control to go from **OFF**, **Man On High** and back to **OFF** again. Press the '▲' or '▼' buttons on the remote to set desired temperature between 5°C and 35°C. Press the 'FROST' button to put the heater into **FROST** Protection mode. Pressing the 'M' button (on the Remote Control) is the only way (using the Remote Control) to bring the heater out of this mode i.e. pressing the '▲' or '▼' buttons on the remote will have no effect on the heater.

## Discard leaking batteries

Dispose of batteries in the proper manner according to Provincial and local regulations. Any battery may leak electrolyte if mixed with a different battery type, if inserted incorrectly, if all the batteries are not replaced at the same time, if disposed of in a fire or if an attempt is made to charge a battery not intended to be recharged.

## Storage

If the radiator is not required for long periods, for example during the summer, it should be stored in a dry place and preferably covered to prevent the accumulation of dirt and dust. The plug and cord can be stored in the storage area provided - see Fig. 14. The cord should be neatly coiled around the hooks provided and the plug inserted into the pin-hole in the central compartment.

## Safety Overheat Protection

For your safety this appliance is fitted with a thermal cut-out. In the event that the product overheats for some reason, the cut-out prevents excessive temperatures on the product by cutting the power to the heater. Once the heater has cooled down, it will reset automatically, it will continue to cycle on and off automatically until the reason for overheating is removed.

## Cleaning

**WARNING - ALWAYS DISCONNECT THE POWER SUPPLY BEFORE CLEANING THE HEATER.**

Do not use detergents, abrasive cleaning powder or polish of any kind on the body of the heater.

Allow the heater to cool, then wipe with a dry cloth to remove dust and a damp cloth (not wet) to clean off stains. Be careful not to allow moisture in to the heater.

## After Sales Service

Please see the separate Warranty leaflet for details of your Warranty & after sales service including contact details.

Should you require after sales service, please get in touch with the supplier through whom you purchased the appliance, or the contract number on your Warranty leaflet.





Glen Dimplex Australia Pty Ltd.  
1/21 Lionel Road,  
Mount Waverley VIC 3149  
Australia

Ph: 1300 556 816  
Web: [www.dimplex.com.au](http://www.dimplex.com.au)

Glen Dimplex New Zealand Ltd.  
38 Harris Road,  
East Tamaki, Auckland  
New Zealand

Ph: 09 274 8265  
Web: [www.dimplex.co.nz](http://www.dimplex.co.nz)